

# CEMENT POWER RESISTOR

SQP (STANDARD TYPE)

SQM (RADIAL TYPE)

SQT (AXIAL TYPE)

SQZ (PCB MOUNTING TYPE)

SQH SQS (CLAMP MOUNTING TYPE)

SQF (FLAT TYPE)

## INTRODUCTION

Cement resistors are manufactured by winding the ceramic rods with metal alloy resistance wire and put it into a fireproof ceramic box then concrete with non-flammable and heat-resistant cement.

## SQP

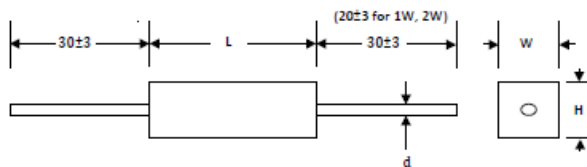

TYPE	RATED WATTS	DIMENSIONS (mm)				RANGE (OHM)
		L±1.5	W±1.5	H±1.5	d±0.1	
SQP-1	1W	14.0	6.0	6.0	0.75	0.10~10K
SQP-2	2W	18.0	7.0	7.0	0.75	0.10~10K
SQP-3	3W	22.0	8.0	8.0	0.75	0.10~33K
SQP-5	5W	22.0	10.0	9.0	0.75	0.10~50K
SQP-7	7W	35.0	10.0	9.0	0.75	0.10~50K
SQP-10	10W	48.0	10.0	9.0	0.75	0.10~50K
SQP-15	15W	48.0	12.5	11.5	0.75	0.10~150K
SQP-20	20W	60.0	14.5	13.5	0.75	0.10~150K
SQP-25S	25W	60.0	14.5	13.5	0.75	0.10~150K

NOTE : Non-Inductive type up to 50Ω

## DERATING CURVE

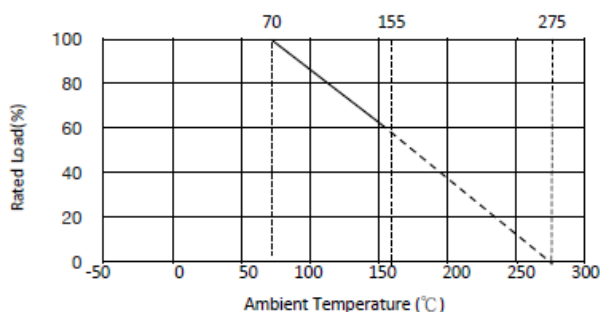

## FEATURE

- Heat and flame resistant!
- The completely insulated characteristic is suitable for printed circuit board.
- For high resistance value, the winding core will be replaced by metal oxide film cutting core (RS type).
- High voltage type and non-inductive type are available on request!

## PERFORMANCE

TEMPERATURE COEFFICIENT	±300PPM/°C ; SPECIAL : LOW TO±25PPM, HIGH TO±1500PPM
INSULATION RESISTANCE	>1,000MΩ
LOAD LIFE (1,000 HOURS)	±5%+0.05Ω
SHORT-TIME OVERLOAD	±2%+0.05Ω
DIELECTRIC WITHSTANDING VOLTAGE	±1%+0.05Ω
MOISTURE RESISTANCE	±5%+0.05Ω
SHOCK AND VIBRATION	±1%+0.05Ω
EFFECT BY SOLDERING	±2%+0.05Ω

## TEMPERATURE RISE

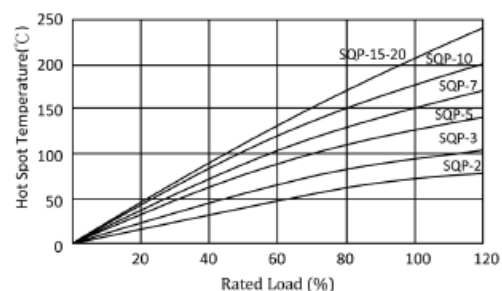

# CEMENT POWER RESISTOR

## SQT

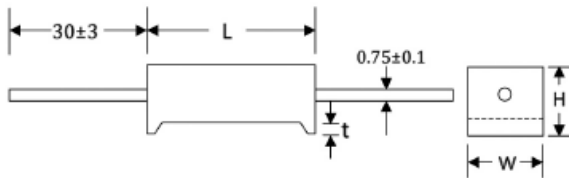

TYPE	RATED WATTS	DIMENSIONS (mm)±1.5mm				RESISTANCE RANGE
		W	H	L	t	
SQT-5	5W	10	9	22	1.5	0.1Ω~50KΩ
SQT-7	7W	10	9	35	3.0	0.1Ω~50KΩ
SQT-10	10W	10	9	48	3.0	0.1Ω~50KΩ

## SQZ

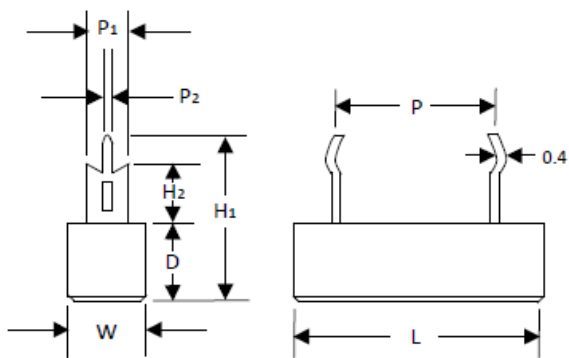

## DERATING CURVE

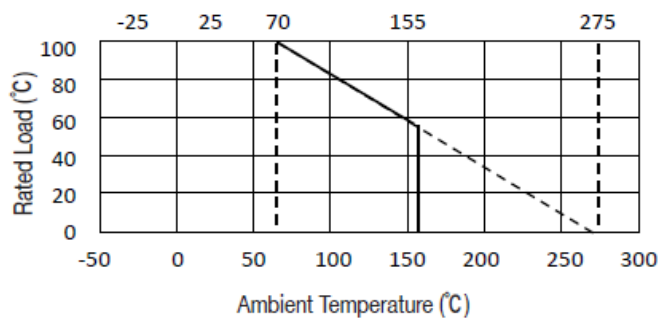

TYPE	RATED WATTS	DIMENSIONS (mm)±1.5mm								RESISTANCE RANGE	
		W	D	L	P	P1	P2	H1	H2	WIREWOUND	RS
SQZ-3	3W	9	9	22	8	5	1.4±0.2	25	10.5	0.1Ω~80Ω	80Ω~50KΩ
SQZ-5	5W	10	9	27	15	5	1.4±0.2	25	10.5	0.1Ω~80Ω	80Ω~50KΩ
SQZ-7	7W	10	9	35	20.5	5	1.4±0.2	25	10.5	0.1Ω~100Ω	100Ω~50KΩ
SQZ-10	10W	10	9	48	30	7	1.4±0.2	25	10.5	0.1Ω~200Ω	200Ω~50KΩ
SQZ-15	15W	12.5	11.5	48	32	10	3±0.5	33	15	1Ω~250Ω	250Ω~150KΩ
SQZ-20	20W	12.5	11.5	63	45±2	10	3±0.5	33	15	1Ω~270Ω	270Ω~150KΩ
SQZ-25	25W	12.5	11.5	63	45±2	10	3±0.5	33	15	1Ω~270Ω	270Ω~150KΩ
SQZ-30S	30W	12.5	11.5	63	45±2	10	3±0.5	33	15	1Ω~270Ω	270Ω~150KΩ

## HEAT RISE CHART

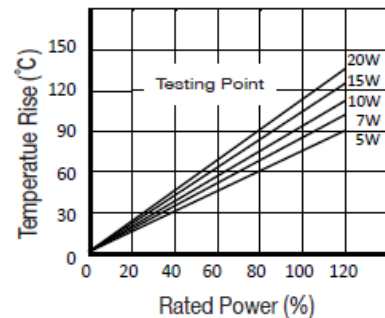

\* The non-kinking tip is also available for SQZ-20 to SQZ-30S.

## SQHG

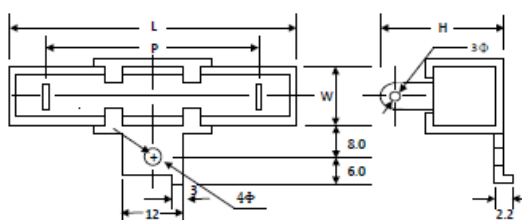

TYPE	RATED WATTS	DIMENSIONS (mm)±1.5mm				RESISTANCE RANGE	
		W	L	P	H	WIREWOUND	RS
SQH-10	10W	10	48	30	18	0.1Ω~200Ω	200Ω~50KΩ
SQH-15	15W	12.5	48	32	21	1Ω~250Ω	250Ω~150KΩ
SQH-20	20W	12.5	63	45±2	21	1Ω~270Ω	270Ω~150KΩ
SQH-30	30W	19	75	56±2	32	2Ω~310Ω	310Ω~1KΩ
SQH-40	40W	19	90	70±2	32	3Ω~350Ω	350Ω~2KΩ

\* Reference Sizes for 10W Chassis Only.

\* SQH : Chassis Excluded.

\* SQHG : Chassis Included .

# CEMENT POWER RESISTOR

## SQS

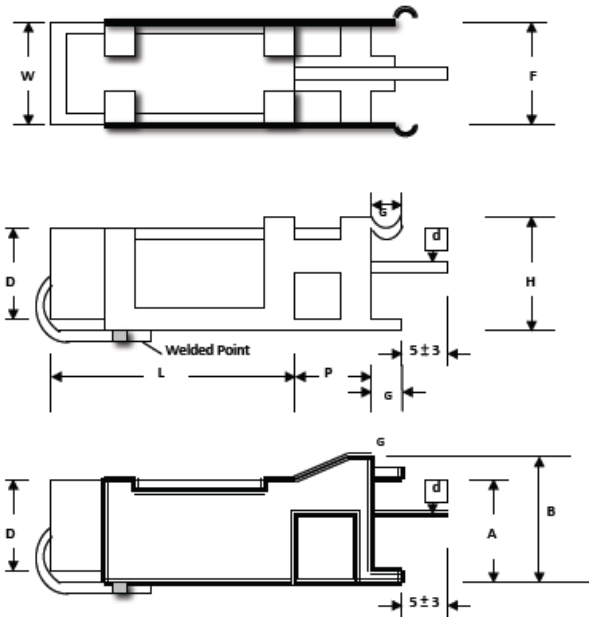

## DERATING CURVE

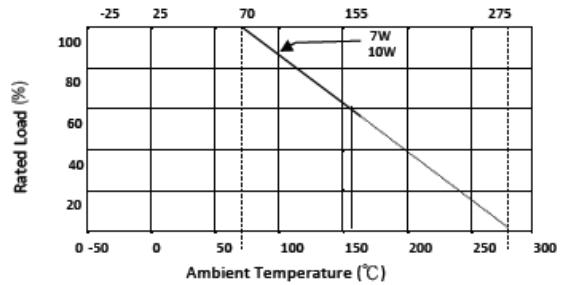

## HEAT RISE CHART

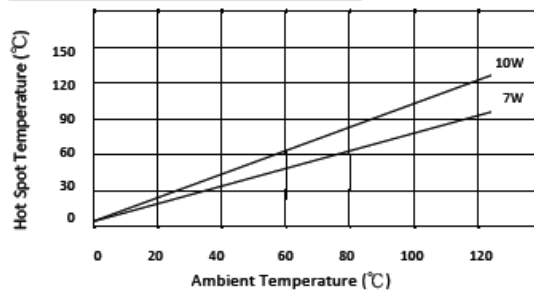

Unit : mm

TYPE	RATED WATTS	W±1.5	D±1.5	L±1.5	P±1.5	d±0.1	F	H±1.0	A±2.0	B±2.0	G±1.0
SQS-5	5W	10	9	22	5	0.75	11±1.0	11			4
SQS-7	7W	10	9	35	8	0.75	11±1.0	11			4
SQS-10	10W	10	9	48	8	0.75	11±1.0	11			4
SQS-20	20W	14	13.5	60	10	0.75	16±2.0		12.5	18	5
SQS-30S	30W	14	13.5	60	10	0.75	16±2.0		12.5	18	5
SQS-40SS	40W	14	13.5	60	10	0.75	16±2.0		12.5	18	5

## SQM

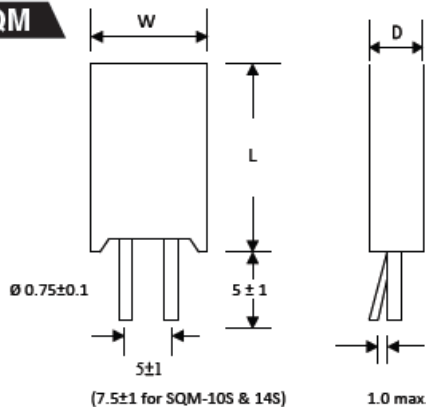

## HEAT RISE CHART

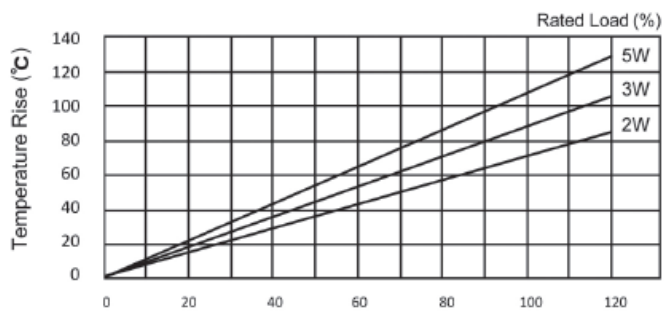

TYPE	RATED WATTS	DIMENSIONS (mm)±1.5mm			RESISTANCE RANGE	
		W	D	L	WIREWOUND	RS
SQM-2	2W	11.5	7.5	20.5	0.1Ω~150Ω	151Ω~33KΩ
SQM-3	3W	12.5	8.5	25	0.1Ω~150Ω	151Ω~33KΩ
SQM-5	5W	12.5	9	25	0.1Ω~200Ω	201Ω~50KΩ
SQM-7	7W	12.5	9	39	0.1Ω~300Ω	301Ω~50KΩ
SQM-10	10W	12.5	9	51	0.1Ω~500Ω	501Ω~50KΩ
SQM-10S	10W	16	12	35	0.1Ω~500Ω	501Ω~50KΩ
SQM-14S	14W	16	12	35	0.1Ω~500Ω	501Ω~50KΩ

# CEMENT POWER RESISTOR

## FEATURES

- Low inductance.
- Safety flameproof construction.
- Thin lightweight body saves the PCB space considerably.
- Tolerance available :  $\pm 10\%$ ,  $\pm 5\%$ ,  $\pm 2\%$

## DIMENSIONS

### SQF

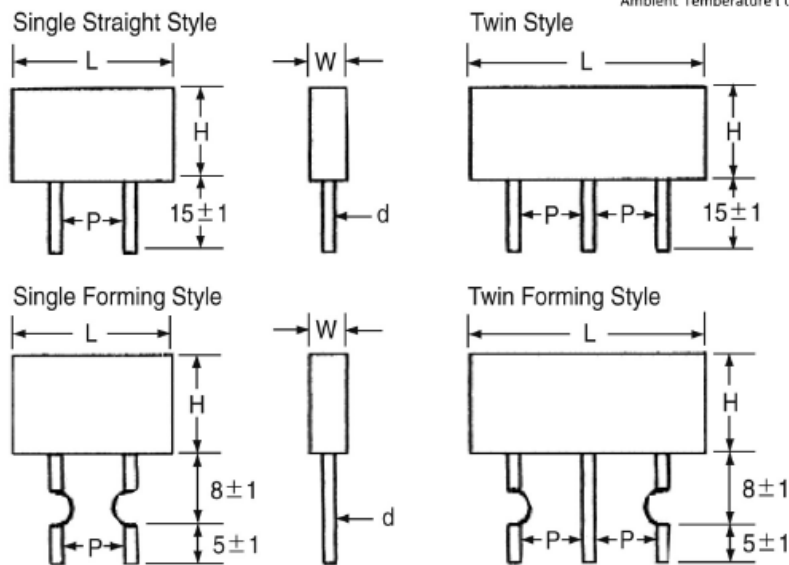

## DERATING CURVE

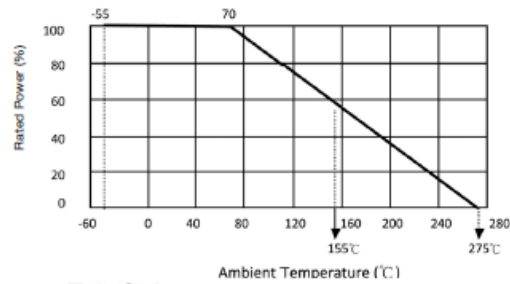

TYPE	POWER RATING AT 70°C	DIMENSIONS (mm)					RESISTANCE RANGE	MAXIMUM WORKING VOLTAGE	MAXIMUM OVERLOAD VOLTAGE
		L $\pm 1.5$	H $\pm 1.5$	W $\pm 1$	d $\pm 0.1$	P $\pm 1$			
SQF-03	3W	13.5	13	5	0.75	10	0.1 $\Omega$ ~ 1 $\Omega$	350V	700V
SQF-05	5W	14	18	5	0.75	10			
SQF-33	3W+3W	26	13	5	0.75	10	0.1 $\Omega$ ~ 0.47 $\Omega$	350V	700V
SQF-55	5W+5W	26	18	5	0.75	10			
SQF-77	7W+7W	26	20	5	0.75	10			

## CHARACTERISTICS

TEST	TEST METHOD	LIMITS	TEST STANDARD
			JIS-C-5201
RESISTANCE TEMP. COEFF.	-55°C ~ +155°C	$\pm 350$ PPM, SPECIAL : LOW TO $\pm 25$ PPM, HIGHT TO $\pm 1$ , 500PPM	4.8
SHORT TIME OVERLOAD	10 times of rated wattage for 5 sec.	$\pm 2\%$	4.13
RATED LOAD	Rated wattage for 30 min.	$\pm 1\%$	4.14
DIELECTRIC WITHSTANDING VOLTAGE	1,000V AC 1 min.	no change	4.7
INSULATION RESISTANCE	500V megger	1,000M $\Omega$	4.6
LOAD LIFE	70°C on-off cycle 1,000 hours	$\pm 5\%$	4.25.1
MOISTURE-PROOF LOAD LIFE	40°C 95% RH on-off cycle 1,000 hours	$\pm 5\%$	4.24
INCOMBUSTIBILITY	16 times of rated wattage for 5 min	not flamed	4.25